

MP2+

Multiple Program Process Temperature Controller

User's / Programming Guide

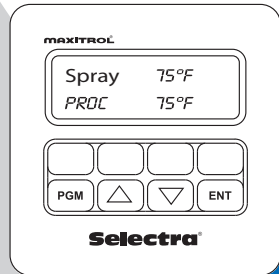

www.maxitrol.com

© 2007 Maxitrol Company, All Rights Reserved

⚠ WARNING

Inappropriate and/or improper installation, adjustment, alteration, service or maintenance can cause property damage, injury or death. Read the installation, operating and maintenance instructions thoroughly before installing or servicing this equipment.

⚠ WARNING

Disconnect power before installation to prevent electrical shock or equipment damage.

FOR YOUR SAFETY

If you smell gas:

- 1 Open windows.
- 2 Do not touch electrical switches.
- 3 Extinguish any open flame.
- 4 Immediately call your gas supplier.

FOR YOUR SAFETY

The use and storage of gasoline or other flammable vapors and liquids in open containers in the vicinity of this control or other appliance is hazardous.

Please read these instructions fully prior to attempting to install, operate, and/or maintain the MP2+ system. Failure to do so may result in improper operation and/or component damage.

⚠ WARNING

Installation shall conform with local codes, or in the absence of local codes, in accordance with the National Fuel Gas Code ANSI Z223.1/NFPA54 or CSA B149.1 as is applicable, and operated in accordance with the manufacturer's instructions. These instructions do not supersede OEM's installation or operating instructions. Installation, inspection, and replacement must be performed by a qualified installer or gas supplier.

This control must be electrically wired in accordance with local codes, or in the absence of local codes, with the National Electrical code, ANSI/NFPA 70 or the Canadian Electrical Code, CSA C22.1 as applicable.

General Statement

The MP2+ system is intended for multiple low temperature process applications, for example paint spray booths or other curing processes. It is ideal for multiple temperature critical and time sensitive process applications requiring temperatures from 60°F to 240°F.

Contents

Warnings	2
General Statement	3
Contents	3
Features	4
Initial Program Selection Menu	4
Process Menu	4
Operation Menu	4
Diagnostic Menu	6
Process Identifier Menu	9
Other Features.....	9
Technical Data	10
Components	10
Menus.....	11
Programming the MP2+ System	12
Initial Menu	13
Process Menu	13
Operation Menu	14
Diagnostic Menu	16
Process Identifier Menu	17
Operation.....	18
MP2+ Multiple Program Process	18
MP2+ Multiple Program w/ TM02 Multifunctional Timer Control.....	19
Wiring Diagram	20
Field Service Checklist	21
Preliminary Circuit Analysis	29
Bandwidth Adjustment.....	30
Valve Adjustments	31
Glossary	33

Initial Programming Menu

Programs

- A maximum of (8) programs are available.
- Each program has a maximum of (8) process set points.
- The program and process set point in use is displayed as P(1-8) S#(1-8).
- Programs utilize global settings.

Global Settings

- Multiple programmable menu settings common to all programs (global) to speed programming and insure consistent heater operation, program to program.

Process Menu

Process Set Point

- A maximum of (8) Process Set Points are available with a temperature range of 60°F (15°C) to 240°F (115°C).
- The Process Set Point is displayed as “SP.”
- Process Set Points not being used can be turned to an “Off” setting.

Process Times (TM02 required)

Any of the (8) Processes can be timed. Each timed Process has a range of 00:00:01 to 23:59:59. The conclusion of a timed Process will immediately proceed into the next Process. If the last Process of the program is timed, it will proceed to the selected start position (see Looping Mode, page 7) after timing out. The letter “T” will be displayed indicating a timed Process. Press the up or down arrows on the TDM02 to scroll between the screens showing the Process Set Point and the sensed temperature AND the sensed temperature with the time remaining in the Process (hh:mm:ss).

Operation Menu

Soft Start (Global Setting)

The Soft Start feature controls the initial rate of voltage change to the modulator. Soft Start operates when switching from a lower Process temperature to a higher Process temperature. It is designed to slow the initial input rate to the burner. This feature is available in three settings: slow, medium, and fast and may be turned off. “Ss” (slow), “Sm” (medium) or “Sf” (fast) is displayed during the time the Soft Start is active. This feature is comprehensive to all Set Points.

Max Valve VDC (Global Setting)

This feature limits the maximum voltage applied to the modulator. It has a setting range of 7 to 25 VDC. This feature is comprehensive to all Set Points.

Max Ramp VDC

This feature limits the maximum voltage applied to the modulator while operating in the Ramping mode. It has a setting range of 5 to 24 VDC. This setting cannot exceed the maximum voltage output setting. This feature is comprehensive to all Set Points.

Total Bandwidth (Global Setting)

This feature determines the amount of temp. change required to drive the modulator from the minimum fire setting to the maximum fire setting and vice versa. This feature is used to eliminate pulsating or hunting due to an oversensitive application. Increase the Bandwidth if a pulsating or hunting condition exists for an extended period of time after a Set Point change. The feature has a range of 5°F (2.8°C) to 15°F (8.3°C). Total Bandwidth is comprehensive to all Set Points.

Offset Temp

This feature is used to maintain a desired temperature in an area not being directly sensed by the MP2+ system. The average difference between the MP2+ sensed discharged temperature and the desired space temperature must be known. This is the Offset. The Offset will set the MP2+ sensed discharged air needed to produce the desired space temperature. Decrease (-) the Offset to maintain and control space temperature lower than MP2+ discharged temperature. Increase (+) the Offset to maintain and control space temperature higher than MP2+ discharged temperature. The space temperature will be displayed as the Process Set Point.

Example



- 1 Program **Offset** to -5°F.
- 2 Program **Process Set Point** (desired space temperature) to 75°F.
- 3 Therefore discharge air temperature = 80°F.
(Required MP2+ discharge air temperature to maintain desired space temperature.)
- 4 The MP2+ discharged air temp. is 80°F. The displayed Process Set Point is 75°F.

The feature has a range of -10°F (-5.6°C) to +10°F (5.6°C) and is available for each Process.

Ramping

This feature is used to step the input rate when changing from one Process Set Point to another. It is available for each Process. The Ramping Rate determines the amount of temperature change per hour in one-minute steps. It has a range of 60 Deg/hr to 900 Deg/hr. The change can be positive or negative.

Example

Process 1 = 75°F

Process 2 = 125°F

Process 2 **Ramp Rate** = 600 Deg/hr or 10 Deg/min

- 1 The control switches from Process 1 to Process 2.
- 2 The controller will immediately raise the temperature 10° and will hold it at the new set point 85°F (75°F + 10°F) until 1 minute has passed.
- 3 It will continue to raise it 10° each subsequent minute until it meets Process 2.
- 4 It will take 5 steps (10°F each) and 4+ minutes to go from 75°F to 125°F.

This feature can be used with Max Ramp VDC and Soft Start to smooth the stepping. (Soft Start only works when Process Temperature increases.)

“Ramp” is displayed to indicate the Ramping feature is active.

Timers

The controller features two Timers (Timer 1 and Timer 2) that accumulate the hours of operation for each Process. Each Process has a Timer 1 and a Timer 2. The TM02 is required.

Timer 1

Timer 1 logs the hours of operation for a Process. It will log up 999 hours at which time it will automatically reset to zero. The hours can be user reset to zero at any time. It also has a programmable alarm setting to notify the user (by flashing a character in the lower right hand corner of the display) when the desired accumulated hours for the Process have been reached. It has a setting range of 1 to 999 hours. The feature is useful in maintaining maintenance requirements.

Timer 2

Timer 2 logs the hours of operation for a Process. It will log up 999 hours at which time it will automatically reset to zero. The hours can be user reset to zero at any time. The feature is useful in maintaining maintenance requirements.

Diagnostic Menu

Max Proc Temp (Global Setting)

This feature limits the maximum temperature for each Process. It has a range of 60°F (15°C) to 240°F (115°C). It does not allow the Process Set Point to be set in excess of the Maximum Process Temperature setting.

Min Proc Temp (Global Setting)

This feature limits the minimum temperature for all Processes. It has a range of 60°F (15°C) to 240°F (115°C). It does not allow any Process Set Point to be set below the Minimum Process Temperature setting.

Calibration

This feature is used to fine-tune a particular application. Calibration shifts the Bandwidth range up or down from the factory set mean. Each application is different with variances in burners and appliances. It can be necessary to change the midpoint of the modulation range to have the Process Temperature and the actual sensed temperature match.

For sensed temperatures consistently displaying lower than the Set Point, increase (+) Calibration by number of degrees off. For sensed temperatures consistently displaying higher than the Set Point, decrease (-) Calibration by number of degrees off. It is available for each Process and has a range of -10°F (-5.6°C) to +10°F (5.6°C).

Monitor (Global Setting)

The Monitor feature is a useful tool when setting up or troubleshooting the MP2+ system. The following will appear on the display when Monitor is in the “On” position:

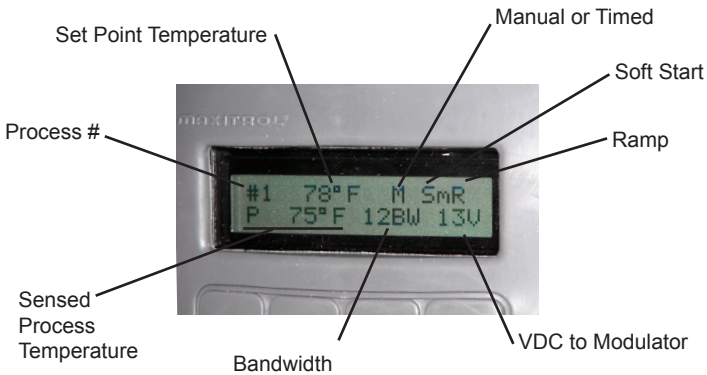

Looping Mode (Global Setting) - TM02 applications only

The looping mode feature is used to select the controllers default position on startup and after the last process of a program is completed.

NOTE: On “Power up” the controller defaults to the last program in use prior to removal of power. After last manual process of a program or after last timed process of a program expires, the controller defaults to the first process of the same program.

Selecting “READY”

Power up:

“READY” is displayed. Requires a momentary switch closure to move the controller to the first process.

After last, manual process of a program:

After momentary switch closure to move out of the last process, controller defaults to the “READY” position.

After last, timed process of a program expires:

Controller defaults to the “READY” position.

Selecting “First Process”

Power up:

Controller begins operating in the First Process of the program.

After last, manual process of a program:

After momentary switch closure to move out of the last process, controller defaults to the First Process.

After last, timed process of a program expires:

Controller defaults to the First Process.

F/C Mode (Global Setting)

This feature sets the control to operate in either the Fahrenheit (F) or Celsius (C) mode.

NOTE: Changing between Fahrenheit and Celsius will reset the control to factory default settings.

Software Version (Global Setting)

Displays the version of software utilized by the controller.

Process Identifier Menu

Process Ident

This feature allows the user to customize the identification of each process in a program. The identifiers are selected from the following list.

Process Identifiers™			
Default	Cure 3	High	Spray 4
Bake	Cure 4	Preheat	Stage 1
Bake 1	Dry	Prep	Stage 2
Bake 2	Dry 1	Purge	Stage 3
Bake 3	Dry 2	Purge 1	Stage 4
Bake 4	Dry 3	Purge 2	Stage 5
Cool down	Dry 4	Purge 3	Stage 6
Cook	Hold	Spray	Stage 7
Cure	Idle	Spray 1	Stage 8
Cure 1	Low	Spray 2	Warm-up
Cure 2	Med	Spray 3	

Other Features

Process Indication Output

The TM02 multifunctional timer control features a Process Indication Output. Processes 1 thru 8 have a dedicated pair of terminals, labeled 1 thru 8 on the TM02. An indicator (LED, relay coil, etc...) 24 VDC 2W maximum can be wired directly to the corresponding terminal block for each Process to be indicated. **Note Polarity**

Program Indication Output

Terminal #9 is used to indicate the controller is operating within a Program. The following voltage will be measured across the #9 terminals:

Note Polarity

Controller in the "READY" position	0 VDC
Controller operating in any of the 8 processes making up a Program	24 VDC 2W max

NOTE:

The technical data listed in this manual does not include normal operating deviations that occur in the actual manufacturing process. The listed specifications may not meet the individual unit's actual specifications. Slight deviations in an individual unit's performance may be encountered due to possible changes in the controlled conditions in which the unit is tested and calibrated. Check ratings given in OEM instructions to assure the MP2+ is suitable for the application.

Power Requirements	Independent 24 VAC, 40 VA capacity transformer	
Ambient Temperature Limits	TDM02	Operating: -40°F(-40°C) to 158°F(70°C) Non-operating: -40°F(-40°C) to 185°F(85°C)
	AM02+ TM02	Operating, Non-operating: -40°F(-40°C) to 185°F(85°C)
Connections	AM02+ to TDM02 = Standard 6 Position 4 Conductor Telephone Cable AM02+ to TM02 = Ethernet Patch Cord	
Sensor	1,000 ohm RTD TS194Q use with mixing tube	
Valves	M411, M511, M611, MR212	

NOTE:

Please read safety warning instructions fully for Maxitrol Modulator Valves [MI2040] prior to attempting to install, operate, and/or maintain the MP2+ system.

Components

- **AM02+** Amplifier
- **TDM02** Remote Selector Display Interface
- **TM02** Auxiliary Multifunctional Timer Control (optional)
- Standard 6 Position 4 Conductor Telephone Cable, 3 feet
- Ethernet Patch Cord, 3 feet

Initial Menu

Programs → Program Set (1-8) → Process Menu → Operation Menu → Diagnostic Menu
Global Settings → Operation Menu → Diagnostic Menu

Process Menu

Process Temperatures → Temp Set Point Process #(1 - 8) → Off, 60°F (15°C) to 240°F (115°C)
Process Time → Time Process #(1 - 8) → Hours, Minutes, Seconds → Manual, 00:00:01 to 23:59:59

TM02
required

Operation Menu

Soft Start → Off, Slow, Medium, Fast
Max Valve VDC → 7 to 25 VDC
Max Ramp VDC → 5 to 24 VDC
Total Bandwidth → 5°F(2.8°C) to 15°F (8.3°C)
Offset Temp → Offset Temp Process #(1 - 8) → -10°F(-5.6°C) to +10°F(5.6°C)
Ramping → Ramping Process #(1 - 8) → Off, 60 Deg/hr to 900 Deg/hr
Timers → Timer Process #(1 - 8)
 Timer 1 → View Hours, Clear Hours, Set Alarm Hours → Set Alarm → 0 hrs to 999 hrs
 Timer 2 → View Hours, Clear Hours

TM02
required

Diagnostic Menu

Max Proc Temp → Max Temp Process #(1 - 8) → 60°F(15°C) to 240°F(115°C)
Min Proc Temp → 60°F(15°C) to 240°F(115°C)
Calibration → Calibration Process #(1 - 8) → -10°F(-5.6°C) to +10°F(5.6°C)
Monitor → On, Off
Looping Mode → Ready, First Process
F/C Mode
Software Version

Process Identifier Menu

Process Ident → Identifier (see list) → Process # (1-8)

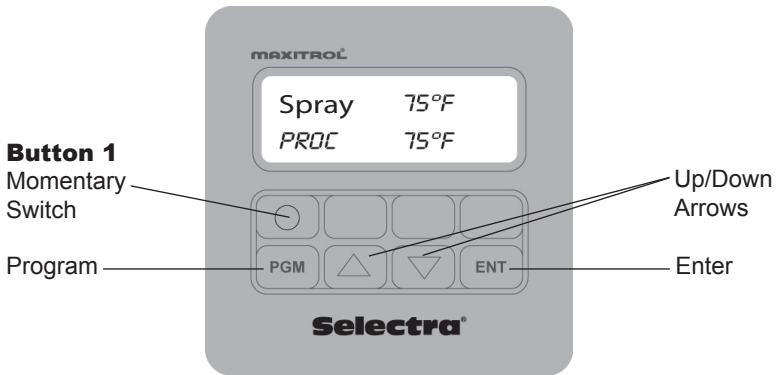

Programming Buttons



- Press once to initially enter programming mode.
- Press once during programming to return to the previous screen.
- Press, hold for 5 seconds and release to EXIT programming mode.



- Press either to scroll or advance through menus.
- Press either to change current value.



- Press once to enter into the selected menu or programming mode.
- Press once to store programmed setting.



- Press and release once to switch to the next Process or to move the controller from the "READY" position to the First Process.
- Press twice or hold for 10 seconds to abort a timed process.

Screen Indicators

- ****STORED**** will appear on the screen to confirm entry accepted.
- **T** indicates a timed process.
- **M** indicates a manual process.

Initial Menu programming:

- 1 Press **PGM** once.
- 2 **Programs** appears, press **ENT** or scroll **▲ ▼** to **Global Settings** and press **ENT**.

Programs selected:

- 3 Scroll **▲ ▼** to desired **Program #** press **ENT**.
- 4 After Program loads, scroll **▲ ▼** to **Process Menu, Operational Menu, Diagnostic** or **Process Identifier Menu** and press **ENT**.
- 5 Proceed to selected **Menu** to continue programming.

Global Settings selected:

- 3 Scroll **▲ ▼** to **Operational Menu** or **Diagnostic Menu** and press **ENT**.
- 4 Proceed to selected **Menu** to continue programming.

Process Menu programming:

Process Temperatures

- 1 Scroll **▲ ▼** to **Temperatures**, press **ENT**.
- 2 **Temp Set Point Process #**, scroll **▲ ▼** to Set Point #, press **ENT**.
- 3 **Set Point Temp Process #, XX°F**, set **▲ ▼** Process Temperature value (OFF, 60°F (15°C) to 240°F (115°C)), press **ENT**.
- 4 ****Stored**** will flash 4 times to confirm entry.
- 5 Repeat steps 1 through 4 for Set Points #(2 - 8).

NOTE: Process #1 CAN NOT be OFF. For unused Process Temperature Set Points, press down arrow until "Off" is displayed. Set Points #(2 - 8) are factory set to "Off."







Process Times (TM02 required)

- 1 Scroll **▲ ▼** to **Times** and press **ENT**.
Each Process can be either Timed or Manual.
- 2 **Time Process #**, scroll **▲ ▼** to Set Point #, press **ENT**.
MANUAL will be the default.
- 3 Scroll **▲ ▼** to **Seconds, Minutes** or **Hours**, press **ENT**.
 - a Set **Seconds, Minutes** or **Hours** value with **▲ ▼**, press **ENT**.







- b ****Stored**** will flash 4 times to confirm entry.
 - c Repeat steps 3 through 3b for each time segment.
for Manual (untimed) Processes
 - d Default setting or when programmed to 00:00:00.
- 4 Repeat steps 1 through 3 for Set Points #(2 - 8).

Operation Menu programming:







Soft Start (Global Setting)

- 1 Scroll   to **Soft Start** and press .
- 2 **Soft Start**, scroll   to **Off, Slow, Medium or Fast**, press .
- 3 ****Stored**** will flash 4 times to confirm entry.

Max Valve VDC (Global Setting)







- 1 Scroll   to **Max Valve VDC**, press .
- 2 **Max Valve VDC**, set   voltage value (7 V to 25 V), press .
- 3 ****Stored**** will flash 4 times to confirm entry.

Max Ramp VDC









- 1 Scroll   to **Max Ramp VDC**, press .
- 2 **Max Ramp VDC**, set   voltage value (5 V to 24 V), press .
- 3 ****Stored**** will flash 4 times to confirm entry.

NOTE: Voltage can not be set greater than Max Valve VDC.

Total Bandwidth (Global Setting)

- 1 Scroll   to **Total Bandwidth**, press .
- 2 **Total Bandwidth**, set   Bandwidth (5°F (-2.8°C) to 15°F (8.3°C)), press .
- 3 ****Stored**** will flash 4 times to confirm entry.









Offset

- 1 Scroll   to **Offset Temp**, press .
- 2 **Offset Temp Process #**, scroll   to Set Point #, press .
- 3 **Offset Temp Process #**, set   Offset (-10°F (-5.6°C) to 10°F (5.6°C)), press .













****Stored**** will flash 4 times to confirm entry.

Repeat steps 1 through 4 for Set Points #(2 - 8).

Ramping

- 1 Scroll   to **Ramping**, press .
- 2 **Ramping Process #**, scroll   to Set Point #, press .
- 3 **Rmp Rate Proc #**, set   Ramp Rate (Off, 60 to 900 Deg/Hr), press .
- 4 ****Stored**** will flash 4 times to confirm entry.
- 5 Repeat steps 1 through 4 for Set Points #(2 - 8).

Timers (TM02 required)

- 1 Scroll   to **Timers**, press .
- 2 **Timer Process #**, scroll   to Set Point #, press .
- 3 **Timer Process #**, scroll   to **Timer 1** or **Timer 2**, press .
- 4 **Timer 1: T1 Proc #**, scroll   to **View Hours**, **Clear Hours** or **Set Alarm Hours**, press .

View hours

a XXX Hours

Clear hours

- b **Are You Sure?** scroll   for Y or N, press .
- c If Y, **Timer1 Hrs Clear** flashes to confirm entry.

Set alarm hours

- d **T1 Proc # Alarm**, scroll   to set hrs, press .
- e **Set Timer1 Alarm** flashes to confirm entry.

- 5 **Timer 2: T2 Proc #**, scroll   to **View Hours** or **Clear Hours**, press .

View hours

a XXX Hours









Clear hours

- b **Are You Sure?** scroll   for Y or N, press .
- c If Y, **Timer2 Hrs Clear** flashes to confirm entry.







- 6 Repeat steps 1 through 5 for Set Points #(2 - 8).

Diagnostic Menu programming:









Max Proc Temp (Global Setting)

- 1 Scroll   to **Max Proc Temp**, press .
- 2 **Maximum Temp Process #**, scroll   to Set Point #, press .
- 3 **Max T Proc #**, set   Temp. value (60°F (15°C) to 240°F (115°C)), press .
- 4 ****Stored**** will flash 4 times to confirm entry.
- 5 Repeat steps 1 through 4 for Set Points #(2 - 8).







Min Proc Temp (Global Setting)

- 1 Scroll   to **Min Proc Temp**, press .
- 2 **Min Proc Temp**, set   Temp. value (60°F (15°C) to 240°F (115°C)), press .
- 3 ****Stored**** will flash 4 times to confirm entry.







Calibration

- 1 Scroll   to **Calibration**, press .
- 2 **Calibration Process #**, scroll   to Set Point #, press .
- 3 **Cal Proc #** set   Temp. value (-10°F (-5.6°C) to 10°F (5.6°C)), press .
- 4 ****Stored**** will flash 4 times to confirm entry.
- 5 Repeat steps 1 through 4 for Set Points #(2 - 8).

Monitor (Global Setting)

- 1 Scroll   to **Monitor**, press .
- 2 **Monitor** set   **On** or **Off**, press .
- 3 Either **Monitor Mode On** or **Off** will flash 3 times to confirm.

Looping (Global Setting)



- 1 Scroll   to **Looping Mode**, press .
- 2 Scroll   to **READY** or **FIRST PROCESS**, press .
- 3 ****Stored**** will flash 4 times to confirm entry.

F/C Mode (Global Setting)

- 1 Scroll   to **F/C Mode**, press .
- 2 **F/C MODE**, scroll   to either **Fahrenheit** or **Celsius**, press .
- 3 ****Stored**** will flash 4 times to confirm entry.









NOTE: Changing between F and C will cause the MP2+ system to reset to factory defaults.

Software Version (Global Setting)

- 1 Scroll   to **Menu Software Version**, press .
- 2 Software Version information will appear.

Process Identifier programming:

Process Ident

- 1 Scroll   to the **Process Ident Menu**, press .
- NOTE: Process Identifier "Default" will appear. Defaults to Set #1, #2 etc.
- 2 Select process identifier by scrolling   to desired identifier, press .
- 3 Select process # attached to selected identifier by scrolling  , press .
- 4 ****Stored**** will flash 4 times to confirm entry.
- 5 Repeat steps 2 through 4 for other process.

MP2+ Multiple Program Process Temperature Controller

Switching to another Program

Switching to another program can only be accomplished by entering the [Initial Programming Menu](#) and selecting "Program Set #".

Switching to Next Programmed Process

Push and release Button 1 on dial face (see page 11) or momentarily latch (make) a set of contacts wired to the TB1 terminal (i.e. typically accomplished by a momentary ON (normally open) switch) to proceed to the next Process. Pushing and releasing Button 1 or momentary latching of TB1 during the last Process of a program will cause the MP2+ System to return to Process 1. Multiple contacts used to switch Processes are to be wired in parallel.

Aborting a Process

Same as switching to next Process, push and release Button 1 or momentarily latch TB1.

MP2+ Multiple Program Process Temperature Controller w/ TM02 Multifunctional Timer Control

Switching to another Program

Switching to another program can only be accomplished by entering the [Initial Programming Menu](#) and selecting “**Program Set #**”.

Switching to Next Programmed Process

Timed processes

Nothing is required. The MP2+ System will immediately proceed to the next programmed Process after timing out.

NOTE: If the last Process of a program is timed, it will proceed either to the “READY” position or to the First Process. By selecting the First Process in the LOOPING Mode menu, the MP2+ can be programmed into a continuous program loop (see page 7, LOOPING Mode).

Untimed (Manual) Processes

An untimed Process will remain in the Process indefinitely until Button 1 is pushed and released or TB1 is momentarily latched. Pushing and releasing Button 1 or the momentary latching of the TB1 will cause the MP2+ System to proceed to the next Process. If the last Process of a program is untimed, pushing and releasing Button 1 or the momentary latching of TB1 will cause the MP2+ system to proceed to the selected program start position. Multiple contacts used to switch untimed Processes are to be wired in parallel.

Aborting a Timed Process

Push and release Button 1 or momentarily latch TB1 twice within a 10 second period or latch and hold continuously for 10 seconds.

Connecting Indicator Relays

Process 1 thru 8 indicators use a corresponding pair of terminals, labeled Relay (1 - 8), on the TM02. The Program indicator uses a corresponding terminal labeled Relay 9. Wire each indicator (LED, relay coil, etc.) 24 VDC 2 W maximum directly to the desired corresponding terminal. See figure A, page 20. Note polarity where applicable.

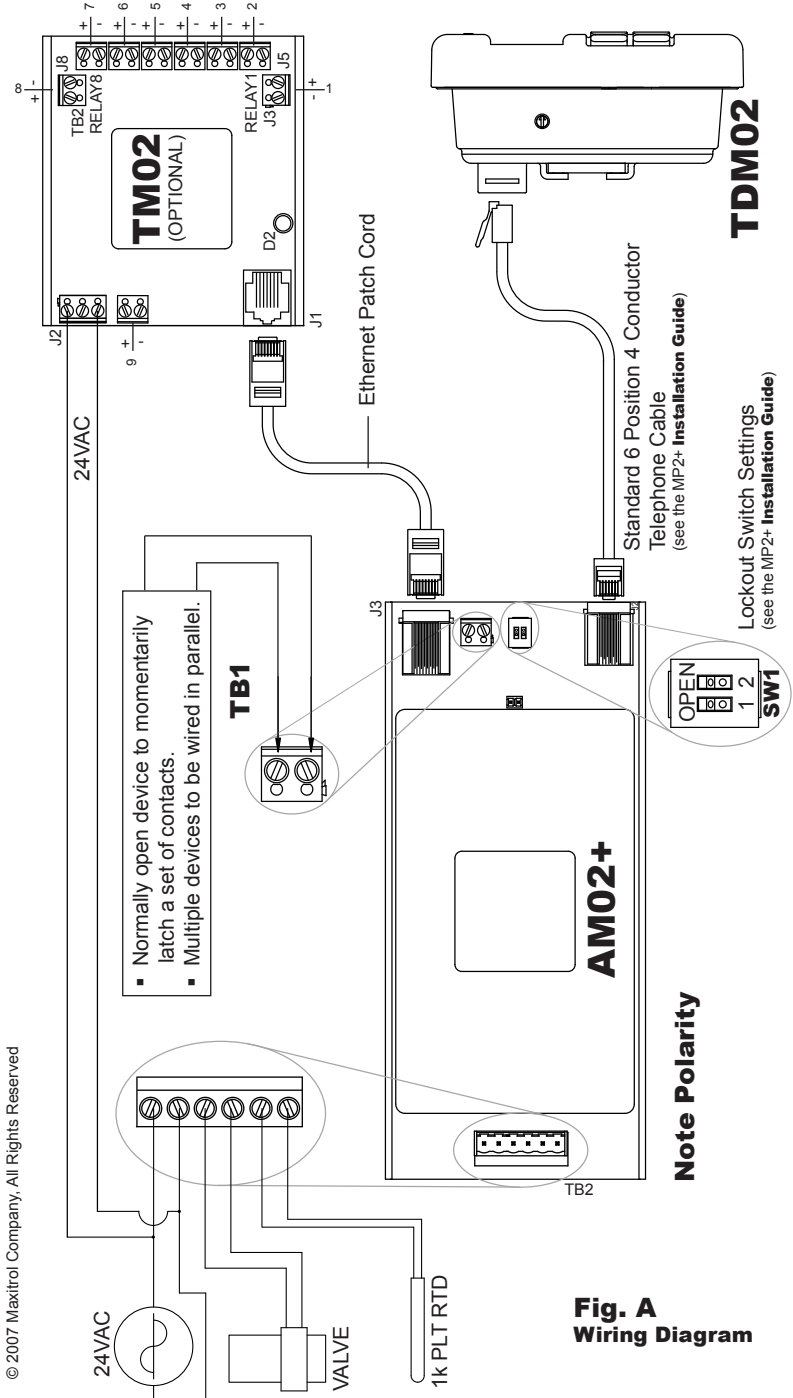

Fig. A
Wiring Diagram

Field Service Checklist

Observed Problem:	Possible Cause:	Remedy:
A. No gas flow.	1. Modulating valve improperly installed.	1. Install with arrow on valve pointing in direction of gas flow.
B. Continuous low fire (electronics problem).	1. Short circuit or no voltage to the amplifier.	1. Prove the power source by checking for 24V AC at amplifier.
	2. Open circuit in TS194(Q) Discharge Air Sensor circuit or wiring.	2. Check TS194(Q) for open circuit. See Temperature Sensor Function of Preliminary Circuit Analysis (pg. 30). Connect test resistor as described in step 2 of Preliminary Circuit Analysis (pg. 29) and follow procedure outlined. Replace TS194(Q) if necessary.
	3. Faulty MP2.	3. Perform Remedy for Possible Cause 1 and 2 above. If modulating voltages are still not obtained, MP2 may be assumed faulty. Replace.
C. Continuous low fire (electronics OK).	1. Short circuit or open circuit in Modulator Coil.	1. Measure resistance across modulator terminals with connecting wires detached. Replace modulator head if not approx 45-55 ohms for M611 Valve, 50-65 ohms for M511 Valve and 60-80 ohms for MR212 and M411 Valves.

Field Service Checklist

Observed Problem:	Possible Cause:	Remedy:
<p>C. Continuous low fire (electronics OK), continued.</p>	<p>2. Plunger missing, jammed or improperly installed.</p>	<p>2. Inspect. Plunger should be smooth, clean and operate freely in solenoid sleeve.</p> <p>Clean or replace plunger if necessary. Do not use lubricants of any type.</p>
<p>D. Incorrect low fire, erratic or pulsating flame.</p>	<p>1. Incorrect by-pass metering adjustment.</p>	<p>1. Adjust to proper low fire. See Valve Adjustments (pg. 31) for low fire adjustment.</p>
	<p>2. Excessive negative burner pressure.</p>	<p>2. Close main gas supply and measure manifold pressure with blower operating. Reading should be less than 1.5" w.c. negative pressure.</p> <p>If reading is greater than 1.5" w.c. negative pressure, check for clogged filters or other inlet air restrictions. Consult factory for other solutions.</p>

Field Service Checklist

Observed Problem:	Possible Cause:	Remedy:
E. Continuous high fire (electronics problem).	1. Short circuit in TS194(Q) Discharge Air Sensor circuit or wiring.	1. Check TS194(Q) for internal short circuit. See <i>Temperature Sensor Function of Preliminary Circuit Analysis</i> (pg. 30). Connect test resistor as described in step 2 of <i>Preliminary Circuit Analysis</i> (pg. 29) and follow procedure outlined. Replace TS194(Q) if necessary.
	2. Faulty MP2	2. Perform Remedy for Possible Cause 1 above. If modulating voltages are still not obtained, MP2 may be assumed faulty. Replace.
F. Continuous high fire (electronics OK).	1. Foreign object holding valve open.	1. Remove bottom plate and inspect valve and seat.
	2. Plunger jammed.	2. Inspect. Plunger should be smooth, clean and operate freely in solenoid sleeve. Clean or replace plunger if necessary. Do not use lubricants of any type.

Field Service Checklist

Observed Problem:	Possible Cause:	Remedy:
G. Incorrect high fire.	1. Inlet pressure too low.	<p>1. Read pressure at inlet to modulating valve using a manometer with unit operating at full fire. Pressure should be equal to the sum of outlet pressure setting plus pressure drop of the valve. See Maxitrol's Capacity Chart, M-MR.MT. EN, (pg. 7).</p> <p>Increase inlet pressure if possible.</p>
	2. Incorrect outlet pressure adjustment of Pressure Regulator.	<p>2. Read manifold pressure using manometer and compare with recommendation of equipment manufacturer.</p> <p>See Valve Adjustments (pg. 31) for high fire adjustment.</p>
H. Erratic or pulsating flame.	1. Hunting.	<p>1. Increase bandwidth setting. See Operation Menu programming on (pg. 14).</p> <p>If flame stabilizes, reduce bandwidth to the minimum setting where a stable flame can be maintained.</p>

Field Service Checklist

Observed Problem:	Possible Cause:	Remedy:
H. Erratic or pulsating flame, continued.	2. Erratic air patterns or improper TS194(Q) location.	2. Connect test resistor as described in step 2 of Preliminary Circuit Analysis (pg. 29). Set point temperature to process temperature being displayed. If the flame is steady, the TS194(Q) should be moved.
	3. Wiring is run next to high voltage switching circuits causing induced voltages.	3. Temporarily wire MP2, TS194(Q) and modulating gas valve externally and observe heater/equipment operation. If smooth operation results, isolate effected wiring from source of induced voltage.
	4. Faulty amplifier or erratic voltage supply.	4. With DC voltmeter connected (per item 2 above) and locally connected (per item 3 above), observe D.C. voltage across modulator terminals. If erratic or unstable D.C. voltages are obtained, the MP2 may be faulty. Replace. If erratic operation continues after replacement, consult Maxitrol Company.

Field Service Checklist

Observed Problem:	Possible Cause:	Remedy:
I. Incorrect discharge air temperature.	1. Incorrect wiring.	1. Check wiring diagrams in <i>MP2(+) Installation Guide</i> (pg. 6) and correct if necessary.
	2. System out of calibration.	2. If sensed temperature (thermometer next to TS194(Q)) does not correspond to MP2 setting. See <i>Calibration Procedure</i> on (pg. 16).
	3. Improper TS194(Q) location.	3. If sensed temperature does not represent average discharge air temperature, move TS194(Q) to location where average representative temperature can be sensed.
J. Burned out transformer.	1. Short circuit in modulator coil.	1. Measure resistance across modulator terminals with wires disconnected. Replace modulator head if less than 40 ohms.
	2. Short circuit between amplifier and modulator valve.	2. Inspect wiring. Correct wiring if short is found using the wiring diagrams in <i>MP2(+) Installation Guide</i> (pg. 6).

Field Service Checklist

Observed Problem:	Possible Cause:	Remedy:
K. Process temperature display reads "Low".	1. Discharge air temperature too low.	1. Raise discharge air temperature to greater than 60°F.
L. Control inoperable; display reads "Ready..."	1. Bad cable connection between dial and amplifier.	1. Remove power. Disconnect and reconnect cable securely. Restore power. If "Ready..." remains, replace or consult Maxitrol Company.
	2. Dial cable disconnected and reconnected with system powered.	2. Remove and restore power. If "Ready..." remains, replace or consult Maxitrol Company.
	3. Incorrect cable.	3. Insure cable type is correct. Replace with correct cable if necessary.
	4. Loss of program.	4. Perform Remedy for Possible Cause 1 and 3 above. If "Ready..." remains, replace or consult Maxitrol Company.

Field Service Checklist

Observed Problem:	Possible Cause:	Remedy:
<p>M. Control resets.</p>	<p>1. Momentary switch wiring is run next to high voltage switching circuits causing induced voltages.</p>	<p>1. Temporarily wire momentary switch externally or disconnect external momentary switch wiring and use integral switch only.</p> <p>If proper operation results, isolate effected wiring from source of induced voltage or use integral switch only.</p>
	<p>2. Momentary loss of power.</p>	<p>2. Prove the power source by checking for 24V AC at amplifier.</p>

Preliminary Circuit Analysis

In order to diagnose the system it is necessary to determine certain values. It is helpful to have a volt/ohm multimeter and a fixed or variable resistance between 1100 and 1300 ohms.

Modulation Function:

If sensed (displayed) process temperature is less than 70°F, perform step 1 below, otherwise continue to step 2.

- 1 Disconnect the sensor wires going to the amplifier and replace with means to obtain a resistance value falling somewhere within the controllers programmed range.

NOTE: “Max Proc Temp” and “Min Proc Temp” settings are located in the Diagnostic Menu in the MP2.

R ohms	Proc T displayed (approx.)
1100	78
1200	125
1300	172

- 2 Connect a DC voltmeter to the modulating gas valve or the modulating gas valve amplifier terminals. DO NOT disconnect existing wiring. **OR** Activate the MP2’s “Monitor” function located in the Diagnostic Menu to display the voltage output to the modulating gas valve.
- 3 Program the temperature “set point” to 10°F below the displayed “process temperature”. The DC volts should read no more than 2 VDC.
- 4 Program the temperature set point to 10° above the displayed “process temperature”. The DC volts should read at a minimum 15 VDC or the programmed “Max Value VDC” setting located in the Operation Menu, whichever is less.

NOTE: Controls programmed with a large Offset Temp or Calibration setting may fail step 3 or 4 due to one or both of the programmed settings. Re-run the failed test with a 20°F set point temperature differential or zero the Offset Temp and Calibration settings. Make note of the settings prior to zeroing and return them to their original setting after test.

Temperature Sensor Function:

- 1 Disconnect the sensor wires at the amplifier. Sensor resistance should measure somewhere between 930 (approx. 0°F) and 1350 ohms (approx. 240°F).

NOTE: An input temperature sensor resistance of less than 1050 ohms will cause the control to display “low” for the process temperature. This is a normal condition. The control will begin displaying the sensed temperature when 1050 ohms (approx. 60°F) or greater is input.

Bandwidth Adjustment

The bandwidth setting will allow the user to control the response of the system. Caution should be exercised in the use of this adjustment.

If hunting is encountered (rapid oscillation), increasing the bandwidth setting will dampen the oscillation - stabilizing the flame.

DO NOT adjust unless necessary. Decreasing the sensitivity will increase the temperature “DROOP” of the system.

NOTE: Bandwidth Adjustment is located in operation menu programming on pg. 14.

NOTE: Low fire adjustment should be checked whenever the high fire adjustment is changed.

MR212 Valve

High Fire Adjustment:

- 1 Short the sensor connection at the amplifier. This drives the valve to continuous high fire condition.
- 2 Remove seal cap (A, Figure 1), and turn regulator pressure adjusting screw to obtain desired manifold pressure. (Clockwise rotation increases pressure.)
- 3 Remove the short to the amplifier sensor connection.

NOTE: If low fire bypass is on maximum, the desired high fire outlet pressure may not be achieved.

Low Fire Adjustment:

- 1 Remove a sensor wire from amplifier terminal. This drives the valve to a continuous low fire condition.
- 2 Remove cap (B, Figure 1), and loosen lock screw (C, Figure 1). Turn (D, Figure 1) to desired low fire adjustment. (Clockwise rotation reduces minimum flow rate.)
- 3 Tighten set screw (C, Figure 1), replace cap (B, Figure 1) and reconnect sensor wire to amplifier.

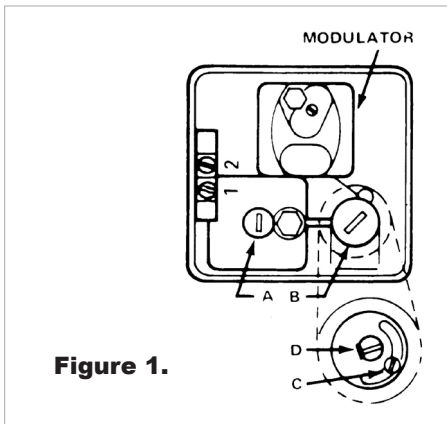

Figure 1.

M411, 511, 611 Valve

High Fire Adjustment:

- 1 Short the sensor connection at the amplifier. This drives the valve to a continuous high fire condition.
- 2 Adjust the pressure regulator to obtain the desired manifold pressure (7" w.c. maximum).
- 3 Remove the short to the amplifier sensor connection.

Low Fire Adjustment:

- 1 Remove a sensor wire from amplifier terminal. This drives the valve to a continuous low fire condition.
- 2 Remove bypass seal cap (A, Figure 2), and turn adjusting screw (B, Figure 2) to desired low fire adjustment. (Clockwise rotation reduces minimum flow rate.)
- 3 Replace cap (A, Figure 2), and reconnect sensor wire to amplifier.

NOTE: See Bulletin M.MR_MT_EN for additional M/MR valve information.

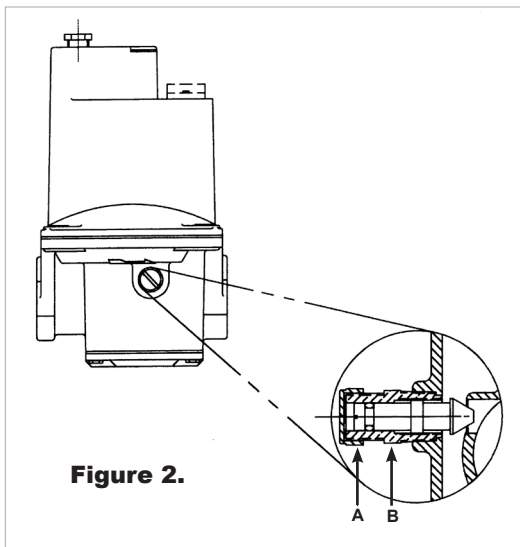

Global Setting

Programmable menu setting which is common to all programs. See “Features” section to identify which menu items are global.

Looping Mode (TM02 applications only)

The looping mode feature is used to select the controllers default position on startup and after the last process of a program is completed (see page 7).

“Manual”

Screen display. It describes the Manual Process.

Manual Process

The (8) Processes can be manually timed. It is an infinite Process that terminates when it is manually switched. A momentary switch closure input to the amplifier is required to proceed to the next Process. A Manual Process displays the letter “M” to indicate it is not a timed Process.

Process

A single programmed temperature, or single programmed temperature and time.

Program

The combination or series of Processes.

“Ready”

Screen display. When selected, it appears prior to the start of a program involving timed processes. A momentary switch closure moves the controller from the “Ready” position to the First Process.



MP2UG-EN.07.2007

© 2007 Maxitrol Company, All Rights Reserved

23555 Telegraph Road Southfield, MI 48033
248.356.1400 tel 248.356.0829 fax
www.maxitrol.com